

#PC-100

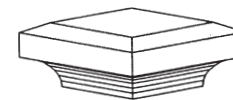

#PC-104

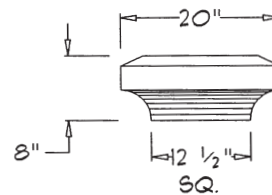
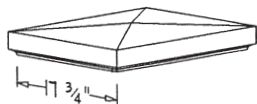
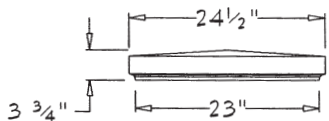

#PC-101

NOTE: NOT SQUARE

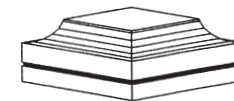
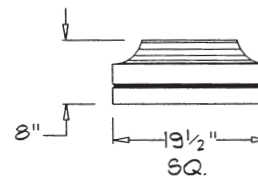

#PC-105

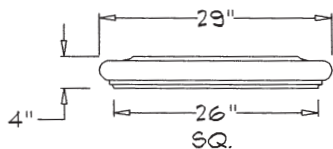

#PC-102

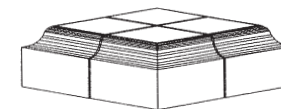
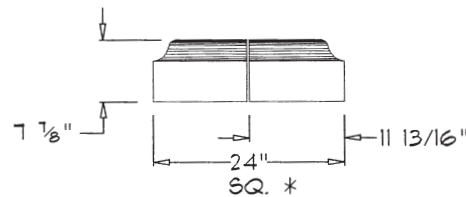

#PC-107-A

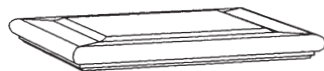
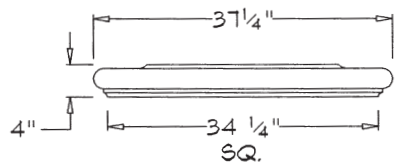

#PC-103

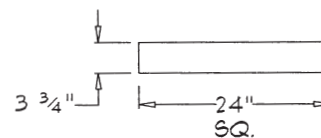

#PC-108

* INCLUDES 3/8" GROUT JOINT.

DATE: 12-6-95

SCALE: 1/2" = 1'-0"

NAPA STONE

LIBRARY OF
BASIC COMPONENTS

PIER CAPS

C8

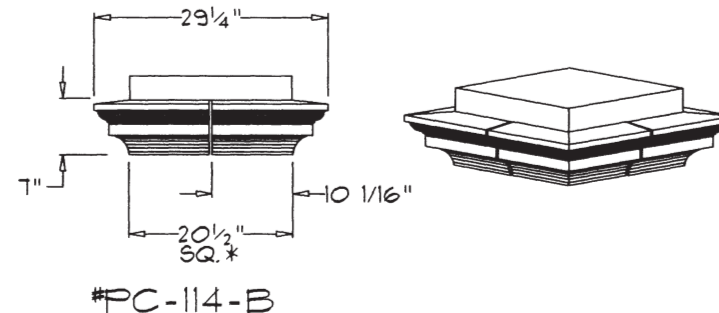
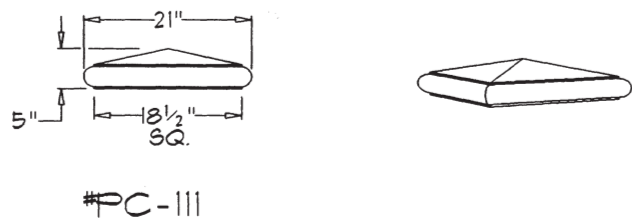
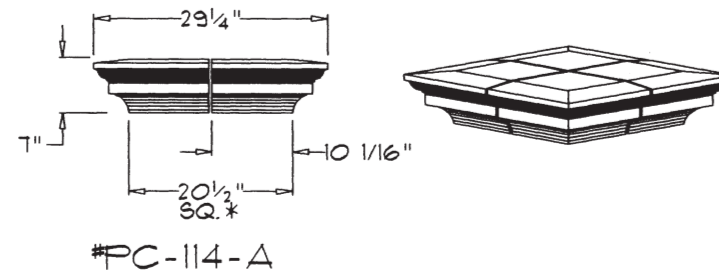
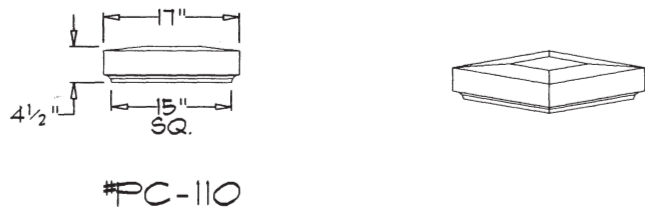
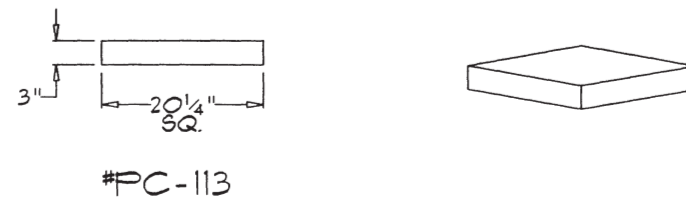
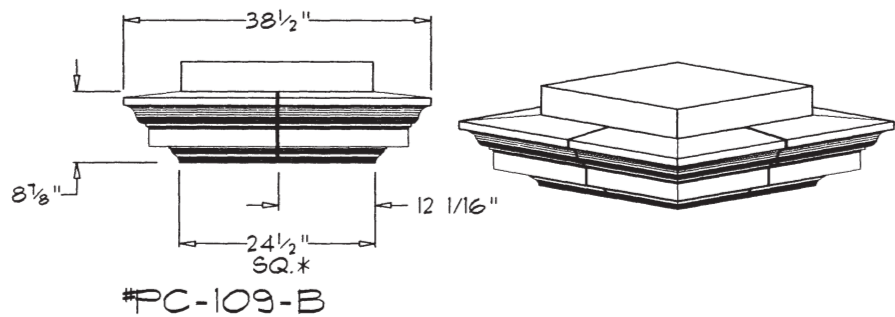
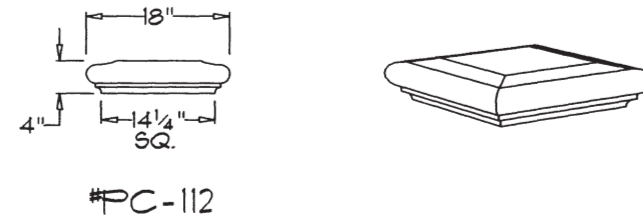
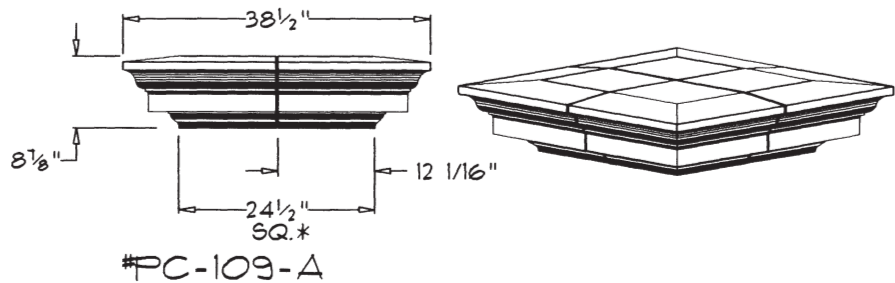

* INCLUDES 3/8" GROUT JOINT.

DATE: 12-6-95

SCALE: 1/2"=1'-0"

NAPA STONE

LIBRARY OF
BASIC COMPONENTS

PIER CAPS

C8.1

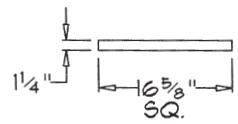

#PC-115

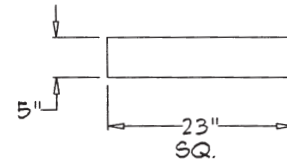
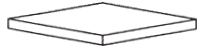

#PC-118

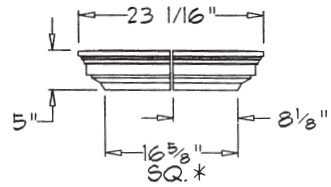
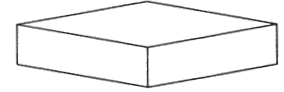

#PC-116-A

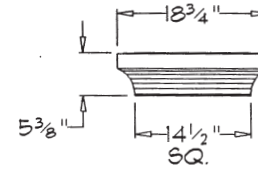
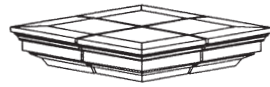

#PC-119

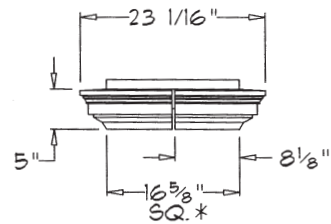
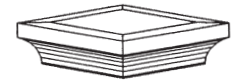

#PC-116-B

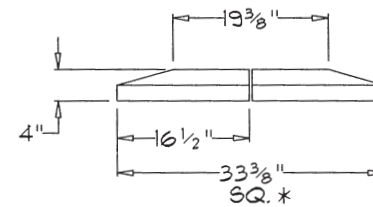

#PC-122-A

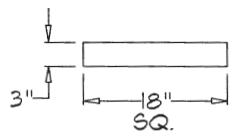
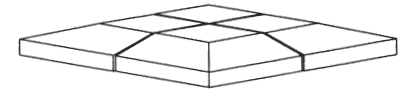

#PC-117

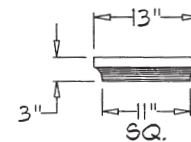

#PC-123

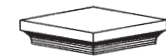

* INCLUDES 3/8" GROUT JOINT.

DATE: 12-6-95

SCALE: 1/2" = 1'-0"

NAPA STONE

LIBRARY OF
BASIC COMPONENTS

PIER CAPS

C8.2

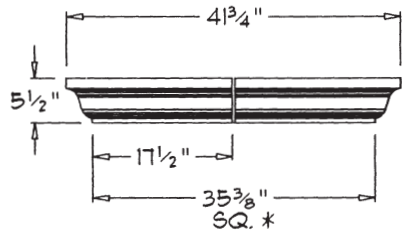

#PC-124-A

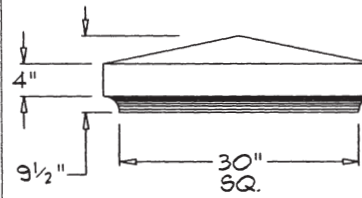
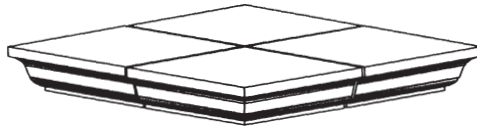

#PC-128

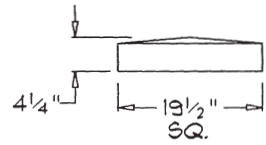
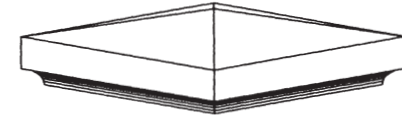

#PC-125

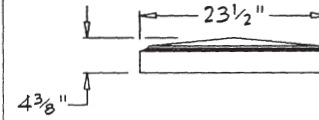
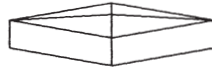

#PC-129

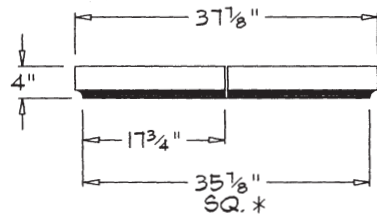
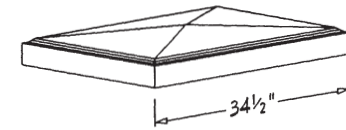

#PC-126-A

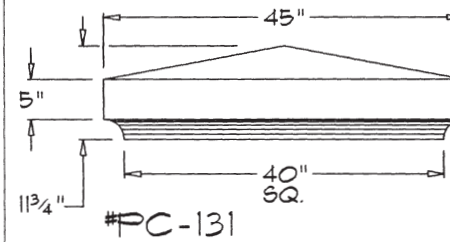
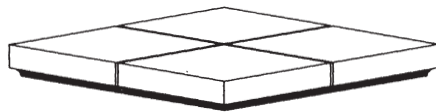

#PC-131

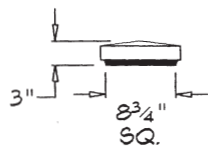
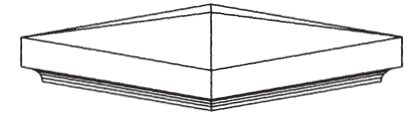

#PC-127

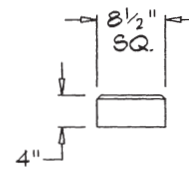

#PC-132



* INCLUDES 3/8" GROUT JOINT.

DATE: 12-13-95

SCALE: 1/2"=1'-0"

NAPA STONE

LIBRARY OF
BASIC COMPONENTS

PIER CAPS

C8.3

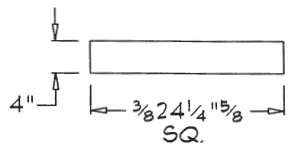

#PC-133



REDUCED

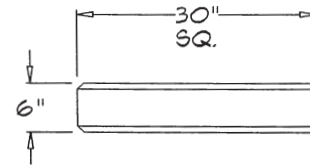

#PC-146

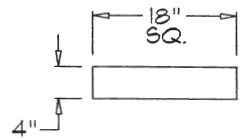
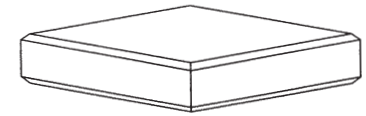

#PC-134

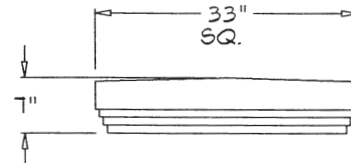
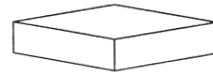

#PC-151

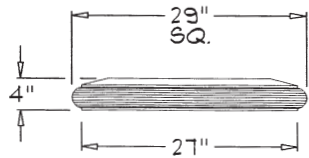
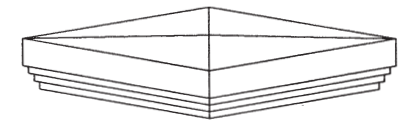

#PC-136

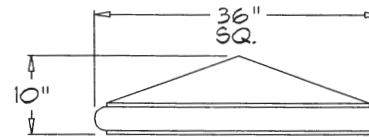
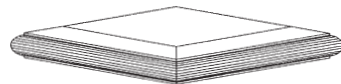

#PC-159

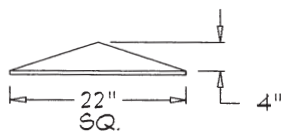
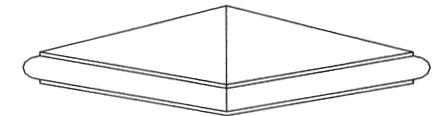

#PC-145

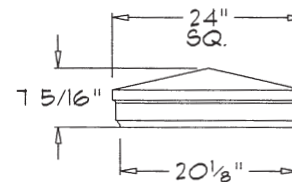
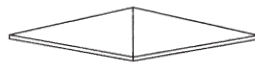

#PC-162

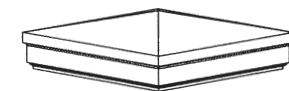

DATE: 3-21-97

SCALE: 1/2" = 1'-0"

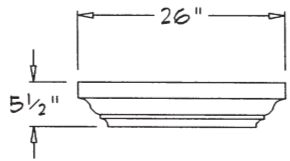

#PC-163 SPL

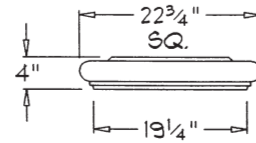
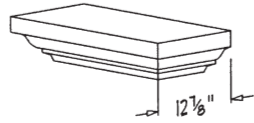

#PC-166

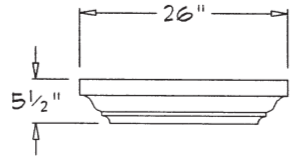

#PC-163-A

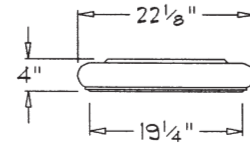
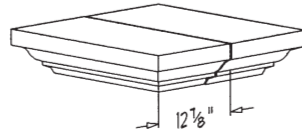

#PC-167

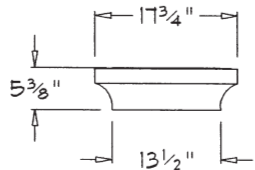
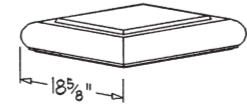

#PC-164

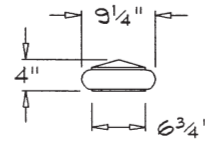
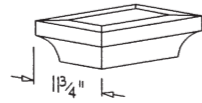

#PC-168

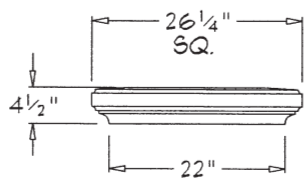
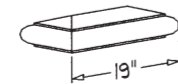

#PC-165

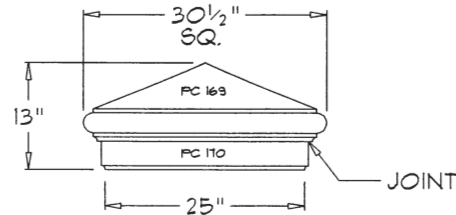

#PC-169 / #PC-170

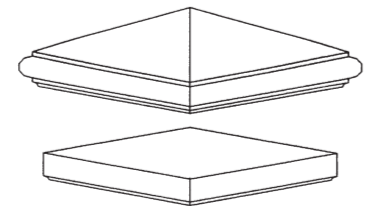

DATE: 3-21-97

SCALE: 1/2" = 1'-0"

NAPA STONE

LIBRARY OF
BASIC COMPONENTS

PIER CAPS

C8.5

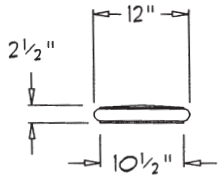

#PC-175

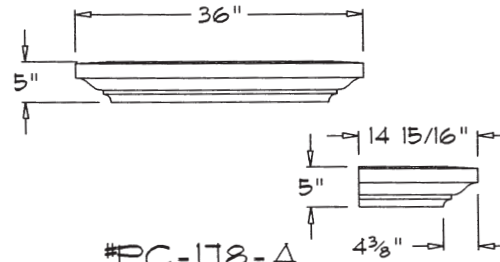

#PC-178-A

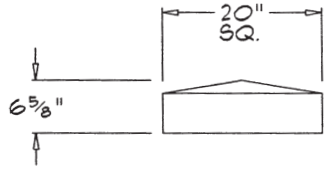
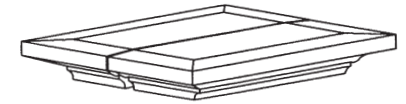

#PC-176

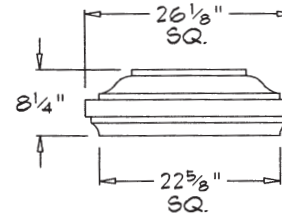
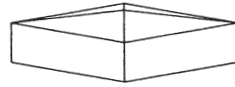

#PC-179

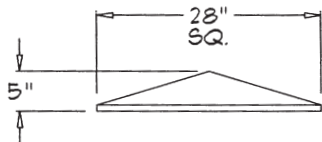
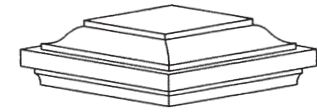

#PC-177

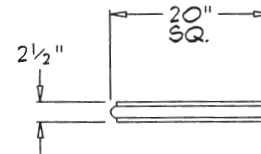
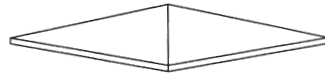

#PC-180

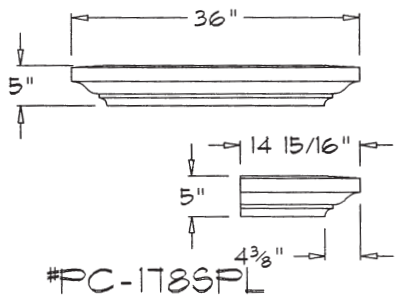
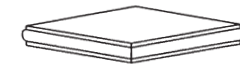

#PC-178SPL

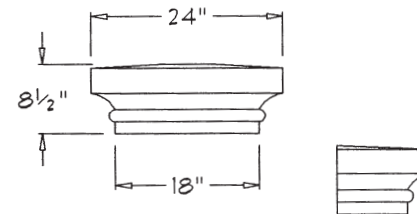

#PC-181 SPL

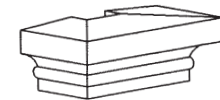
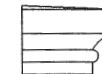

DATE: 3-21-97

SCALE: 1/2" = 1'-0"

NAPA STONE

LIBRARY OF
BASIC COMPONENTS

PIER CAPS

C8.6

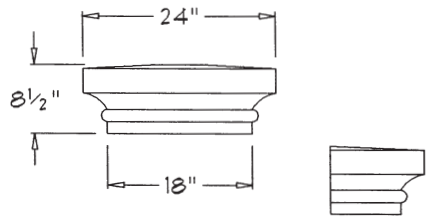

#PC-181-A

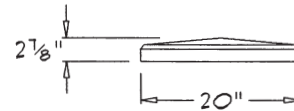
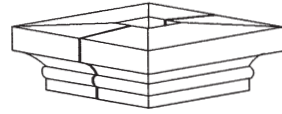

#PC-185 SPL

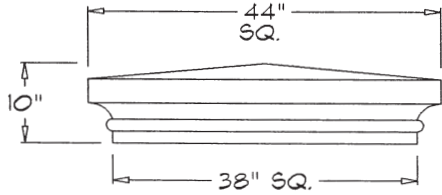
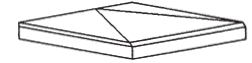

#PC-182

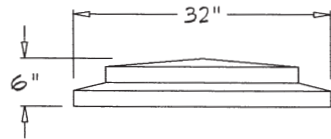
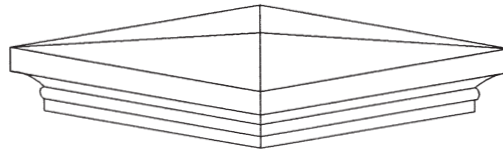

#PC-183

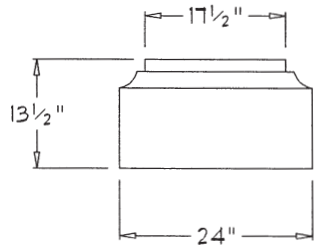
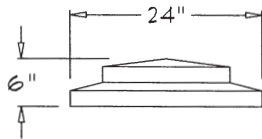
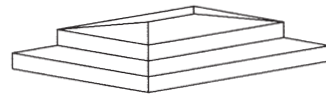

#PC-184-A

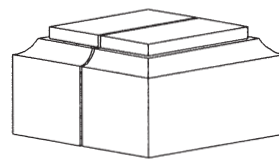
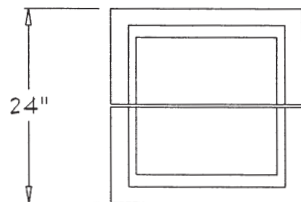

DATE: 3-21-97

SCALE: 1/2"=1'-0"

NAPA STONE

LIBRARY OF
BASIC COMPONENTS

PIER CAPS

C8.1

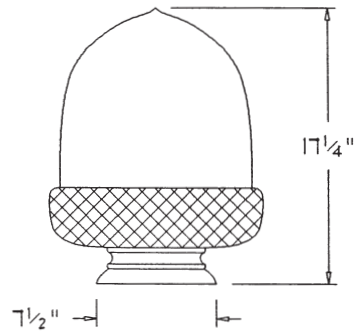

PC-900F 12"D.

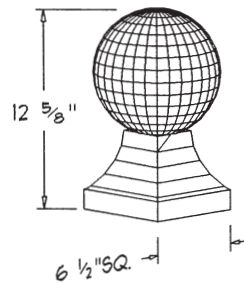

PC-901F 8"D.

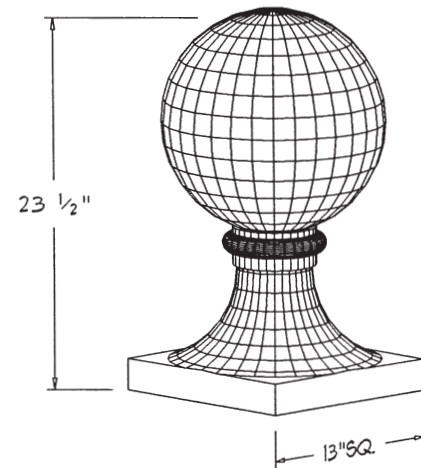

PC-902F 14"D.

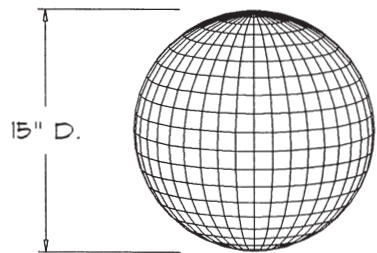

2" D. FLAT SPOT

PC-905F 15"D.

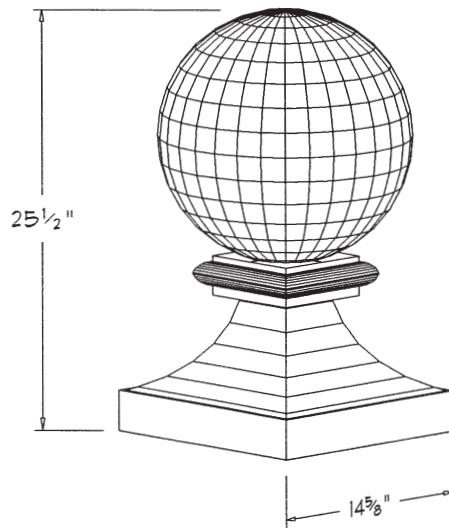

PC-903F 15"D.

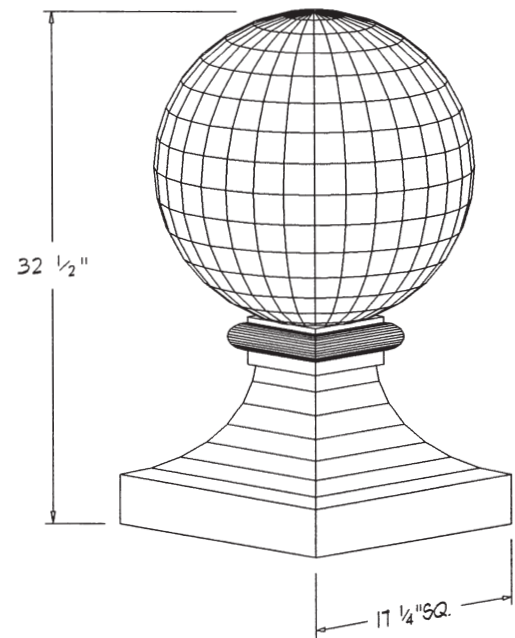

PC-904F 20"D.

DATE: 12-6-95

SCALE: N.T.S.

NAPA STONE

LIBRARY OF
BASIC COMPONENTS

PIER CAPS

C8.8

Component	Pier Cap Description	Size	Weight
PC-100	Square Pier Cap	22-1/2" x 5" x 22-1/2"	145
PC-101	Rectangle Pier Cap	19-1/4" x 3-3/4" x 22-1/2"	106
PC-102	Square Pier Cap	29" x 4" x 29"	226
PC-103	Square Pier Cap	37-1/4" x 4" x 37-1/4"	377
PC-104	Square Pier Cap	20" x 8" x 20"	176
PC-105	Square Pier Cap	19-1/2" x 8" x 19-1/2"	222
PC-107CN	<i>Quarter Pier Cap, Square Outside Corner Piece</i>	<i>11-13/16" x 7-7/8" x 11-13/16"</i>	78
PC-108	Square Pier Cap	24" x 3-3/4" x 24"	162
PC-109CN	<i>Quarter Pier Cap, Square Outside Corner Piece</i>	<i>19-1/4" x 8-7/8" x 19-1/4"</i>	170
PC-110	Square Pier Cap	17" x 4-1/2" x 17"	83
PC-111	Square Pier Cap	21" x 5" x 21"	132
PC-112	Square Pier Cap	18" x 4" x 18"	97
PC-113	Square Pier Cap	20-1/4" x 3" x 20-1/4"	92
PC-114CN	<i>Quarter Pier Cap, Square Outside Corner Piece</i>	<i>14-5/8" x 7" x 14-5/8"</i>	82
PC-115	Square Pier Cap	16-5/8" x 1-1/4" x 16-5/8"	26
PC-116CN	<i>Quarter Pier Cap, Square Outside Corner Piece</i>	<i>11-17/32" x 5" x 11-17/32"</i>	41
PC-117	Square Pier Cap	18" x 3" x 18"	73
PC-118	Square Pier Cap	23" x 5" x 23"	198
PC-119	Square Pier Cap	18-3/4" x 5-3/8" x 18-3/4"	138
PC-122CN	<i>Quarter Pier Cap, Square Outside Corner Piece</i>	<i>16-1/2" x 4" x 16-1/2"</i>	68
PC-123	Square Pier Cap	13" x 3" x 13"	32
PC-124CN	<i>Quarter Pier Cap, Square Outside Corner Piece</i>	<i>20-1/16" x 5-1/2" x 20-1/16"</i>	153
PC-125	Square Pier Cap	19-1/2" x 4-1/4" x 19-1/2"	74
PC-126CN	<i>Quarter Pier Cap, Square Outside Corner Piece</i>	<i>18-3/4" x 4" x 18-3/4"</i>	105
PC-127	Square Pier Cap	10" x 3" x 10"	23
PC-128	Square Pier Cap	34" x 9-3/4" x 34"	412
PC-129	Rectangle Pier Cap	23-1/2" x 4-3/8" x 34-1/2"	256
PC-131	Square Pier Cap	45" x 11-3/4" x 45"	1087
PC-132	Square Pier Cap	8-1/2" x 4" x 8-1/2"	22
PC-133CN	<i>Quarter Pier Cap, Square Outside Corner Piece</i>	<i>24-1/4" x 4" x 24-1/4"</i>	99
PC-134	Square Pier Cap	4" x 18" x 18"	97
PC-136	Square Pier Cap	29-3/8" x 4" x 29-3/8"	275
PC-141	2" Bullnose Edge, Flat Top	29-3/8" x 4" x 29-3/8"	259
PC-143	Square Pier Cap, Peaked Top	46" x 8" x 46"	866
PC-144	Square Pier Cap, Peaked Top	34" x 7-1/4" x 34"	498
PC-145	Square Pier Cap, Peaked Top	22" x 3-1/2" x 22"	42
PC-146	Square Pier Cap, Flat Top	30" x 6" x 30"	405
PC-152	Square Pier Cap	20" x 4" x 20"	120
PC-153	Square Pier Cap	30-1/4" x 5-1/2" x 30-1/4"	377
PC-154	Square Pier Cap	18-3/4" x 5-1/2" x 47-3/4"	369
PC-155	Square Pier Cap	26" x 4" x 26"	203
PC-156	Square Pier Cap	44-1/4" x 8-7/8" x 44-1/4"	1088
PC-157	Square Pier Cap	28" x 7" x 28"	412

Napa Stone

LIBRARY OF
BASIC COMPONENTS

Pier Caps

C8.10

